

STS Series

Superior Temperature Reference Sensors

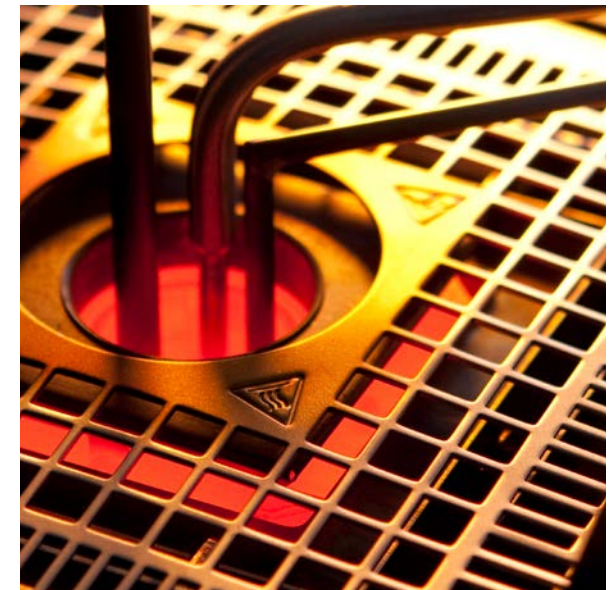

Product Description

STS SUPERIOR TEMPERATURE REFERENCE SENSORS are a series of high quality sensors, ideal for industrial temperature calibration applications where accuracy and long-term stability are important. STS sensors are based on more than 50 years of industrial temperature sensor manufacturing experience.

Features

The main requirement of a reference sensor is stability: The less the sensor drifts, the lower the measurement uncertainty. All JOFRA Superior Temperature Reference Sensors are economical and offer fast response times, low immersion depths, compact physical sizes, and specified low drift rates — even at high temperatures. These are all important considerations when selecting a reference sensor.

In addition to the standard straight sensors, we offer a special cable type reference sensor, permitting the sensor to be positioned throughout the depth of the well in a dry block (for example) under a sanitary flange. In addition, we have a specific series of intelligent sensors developed for use with the DTI050 reference indicator.

Key Features

- ▶ **Wide Temperature Range**
-150 to 700° C (-238 to 1292° F). A single sensor may cover the complete temperature range.
- ▶ **Fast Response Time**
Ensures correct monitoring of temperature stability in liquid baths or dry-block calibrators.
- ▶ **Specified Low Drift**
Maintains a minimal uncertainty budget over the entire period between re-calibration intervals. Allows for easier recalibration scheduling.
- ▶ **Calibration Certificate**
Wide choice of accredited and traceable certificates.

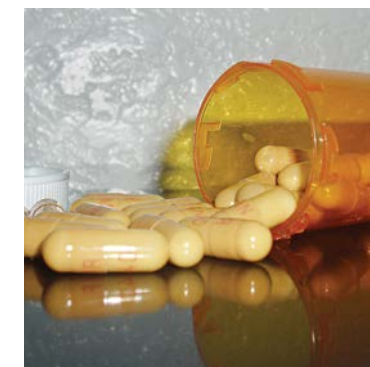
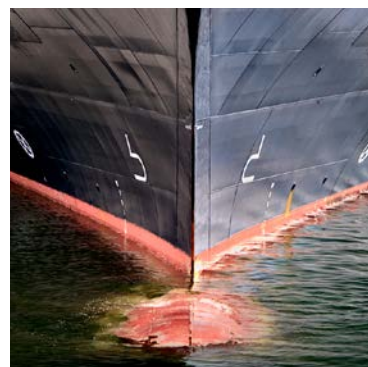
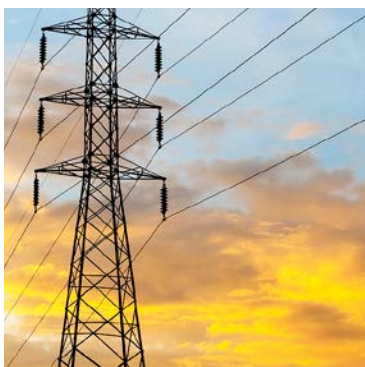

STS-050

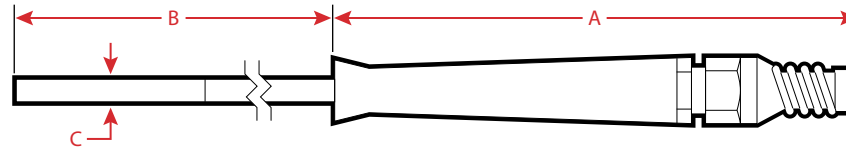

Measuring Temperature with Intelligent Sensors

The STS-050 reference sensors use intelligent detection technology, meaning that they are able to automatically read calibration data and sensor type from a memory chip placed in the sensor. This chip is standard in the STS-050 series.

The intelligent sensor reading makes it possible to change the sensors without re-programming the DTI050. When an intelligent sensor is connected, all information about the sensor, such as serial number, calibration data, and coefficients are read by the DTI050. All information can be shown on the display in the config menu for verification. Recalling existing data eliminates potential errors which may occur as a result of programming the sensor.

Standard Delivery

STS-050 A sensor with handle ■ Sensors delivered in carton box
 ■ Traceable calibration certificate, 6 points from -45 to 400° C ■
 Cable – according to order number ■ User manual.

Specifications

Dimensions	
Reference A	140 mm (5.51 in)
Reference B	250 mm (9.84 in) 350 mm (13.78 in)
Reference C	4 mm (0.16 in)
Temperature Range	
All Sensors	-50 to 400° C (-58 to 752° F)
Accuracy	
Hysteresis ⁽¹⁾ @ 0° C (32° F)	0.01° C (0.02° F)
Long Term Stability ⁽²⁾ @ 0° C (32° F)	typical 0.014° C (0.025° F)
Repeatability ⁽¹⁾ @ 0° C (32° F)	0.005° C (0.009° F)
⁽¹⁾ When used in the range -50 to 400° C (-58 to 752° F).	
⁽²⁾ When exposed to 400° C (752° F) for 100 hours. Stability will depend on actual use of the sensor.	
Sensing Element	
Type	Pt100
Nominal Resistance @ 0° C (32° F)	100 Ω
Temperature Coefficient	$\alpha_{100} = 0.00385$ 1/°C
Minimum Immersion Depth	
STS-050 A – 4 mm (0.16 in)	60 mm (2.36 in)

Self-Heating Effect	
	0.04° C/mW (0.07° F/mW)
Response Time	
STS-050 A – 4 mm (0.16 in): $\tau_{0.5}$ (50%)	7 seconds
STS-050 A – 4 mm (0.16 in): $\tau_{0.9}$ (90%)	17 seconds
Liquid in motion $v = 0.4$ m/s.	
Electrical Connections	
Cable	4-wire
Connection	REDEL goldplated
Insulation Resistance	
@ 23° C (73° F)	100 Gohm
@ 400° C (752° F)	70 Mohm
Outer Tube	
	AISI 316
Operating Conditions	
Sensor, Connection, and Cable	Max. 70° C (158° F)
Storage Temperature	-20 to 70° C (-4 to 158° F)
Humidity	0 to 90% RH
Protection Class	DIN 40050 IP-50

Ordering Information

Base Model Number	Sensor Diameter	Shape and Length	Cable Length and Termination	Calibration Certificate
STS050	A	—	D	—
Pt100 reference sensor, solid, with handle, -50 to 400° C (-58 to 752° F)	Overall diameter 4 mm (0.16 in)	Straight sensor, 250 mm (9.8 in) in carton ... 250 Straight sensor, 350 mm (13.8 in) in carton ... 350	1 m (3.3 ft), with REDEL connector for DTI050	Traceable certificate to international standards. Standard -45 to 400° C ... F Accredited certificate. ISO17025. Option -45 to 400° C ... H

Sample Order Number

STS050A250DF ... 4 mm STS-050 reference sensor, straight 250 mm, cable length 1 m (3.3 ft) with REDEL connector for DTI050, and NPL traceable calibration certificate.

STS-100 A/B



Quality Defined

It is not easy to make a good quality reference sensor. The main requirement of a reference sensor is stability. This means minimal drift as a function of operating time at the actual temperature. The less the sensor drifts, the lower the measurement uncertainty.

Standard Diameter — Fast Response

The STS-100 A/B series has a relatively small diameter: STS-100 A is 4 mm / 0.16 in, and STS-100 B is 6.35 mm / 0.25 in. This leaves optimum space for sensors-under-test in the dry-block, and ensures a fast response time. A fast reacting sensor will optimize the measurement information.

Reduced Hysteresis and Drift

The sensing element is comprised of a pure platinum coil. This coil is suspended in a way that minimizes stress and ensures a near zero hysteresis value.

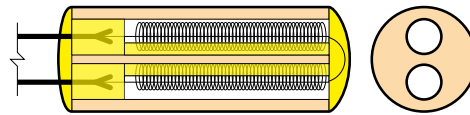

The main reason for drift within a sensor assembly is impurities within the element, especially at temperatures above 350° C (660° F). All internal parts must be cleaned thoroughly. AMETEK has developed a unique cleaning method for the internal bore of the Inconel® sheath. The platinum sensor is embedded within an ultra-clean, temperature resistant ceramic; and assembly of the components is performed in a clean room. These precautions ensure minimum contamination of the element during use, and provide the user with the best possible performance.

Aging /Annealing

Once the sensors are assembled, they are subjected to a long approval process. This includes mechanical stress reduction of the entire assembly as well as aging the sensor element itself. The purpose of aging the sensor is to remove the initial drift.

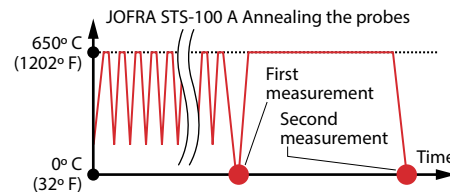

The procedure involves heating the sensor up to 650° C (1202° F) and holding it for 1 hour before cooling down. This process is repeated over a period of several days. The resistance is then measured at 0° C (32° F) and recorded. The sensor is again heated up to 650° C (1202° F), and this time the temperature is held constant for 100 hours.

Finally the output from the sensor is again measured at 0° C (32° F) and recorded. The difference between the first and second measurement is recorded. The difference between these two measurements is our verification of the stability qualities of the sensor. To be accepted for final calibration and certification, the sensor must meet our minimum tolerance, which we document in a quality certificate.

Reduced Isolation — Resistance-Error

Electrical isolation resistance (parasite-resistance-error) when measured at the highest operating temperature should be as high as possible. A low isolation resistance would cause the output signal to be incorrect in relation to the temperature. JOFRA STS-100 A/B series sensors meet the IEC-751 requirements of isolation resistance by several hundred percent.

The Final Quality-Certificate-Check

Upon completion of every certificate, after final calibration of the sensor, examination and approval cycles are performed according to our established procedures. The critical verification is to ensure that the difference between the initial and the final 0° C (32° F) measurement on the certificate meets our minimum tolerance. These requirements are based on a vast amount of data, which has been evaluated statistically. This value indicates if the sensor has a sufficient long-term stability. We also check that the linearization coefficients have values that correlate to an acceptable curve sequence in accordance with our requirements.

Certification

The final documentation on sensors is the calibration certificate. JOFRA sensors have the following calibration options.

Accredited Certificate (Standard) Traceable to the European Accreditation Organization. Temperature range from -45 to 650° C (-49 to 1202° F).

The certificate contains a minimum of 6 temperature points starting and ending at 0° C (32° F). The certificate also contains calculated linearization coefficients.

Delivery Without Certificate — Annealed Only (Optional) In some cases, the customer may prefer to calibrate the sensor themselves. It is possible to purchase the sensor without any certification. We do not recommend this option because we are not able to complete the final “quality-certificate-check.”

STS-100 A/B

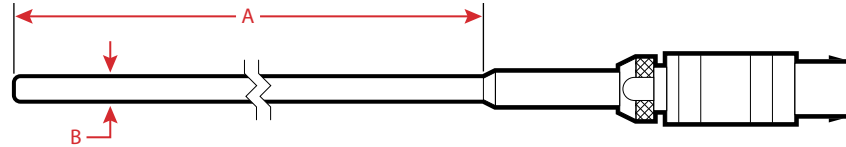

Specifications

Dimensions

Reference A	250 mm (9.84 in)
	350 mm (13.78 in)
	500 mm (19.69 in)
Reference B	4 mm (0.16 in)
	6.35 mm (0.25 in)

Temperature Range

All Sensors -150 to 650° C (-238 to 1202° F)

Accuracy

Hysteresis ⁽¹⁾ @ 0° C (32° F)	0.01° C (0.02° F)
Long Term Stability ⁽²⁾ @ 0° C (32° F)	typical 0.014° C (0.025° F)
Repeatability ⁽¹⁾ @ 0° C (32° F)	0.002° C (0.0036° F)

(1) When used in the range -90 to 650° C (-130 to 1202° F).

(2) When exposed to 650° C (1202° F) for 100 hours. Stability will depend on actual use of the sensor.

Sensing Element

Type	Pt100
Nominal Resistance @ 0° C (32° F)	100 Ω
Temperature Coefficient	$\alpha_{100} = 0.00385$ 1/°C

Minimum Immersion Depth

STS-100 A – 4 mm (0.16 in)	100 mm (3.9 in)
STS-100 B – 6.35 mm (0.25 in)	110 mm (4.3 in)

Self-Heating Effect

0.06° C/mW (0.108° F/mW)

Response Time

STS-100 A – 4 mm (0.16 in): $\tau_{0.5}$ (50%)	8 seconds
STS-100 A – 4 mm (0.16 in): $\tau_{0.9}$ (90%)	26 seconds
STS-100 B – 6.35 mm (0.25 in): $\tau_{0.5}$ (50%)	18 seconds
STS-100 B – 6.35 mm (0.25 in): $\tau_{0.9}$ (90%)	44 seconds

Liquid in motion $v = 0.4$ m/s.

Electrical Connections

Cable	4-wire plus shield
Connection	LEMO goldplated

Insulation Resistance

@ 23° C (73° F)	100 Gohm
@ 650° C (1202° F)	70 Mohm

Outer Tube

Inconel 600

Operating Conditions

Sensor, Connection, and Cable	Max. 70° C (158° F)
Storage Temperature	-20 to 70° C (-4 to 158° F)
Humidity	0 to 90% RH
Protection Class (connectors)	DIN 40050 IP-50

Shipping Dimensions

LxW.H	750x140x140 mm (29.5x5.5x5.5 in)
Shipping Weight, including packing	1.9 kg (4.2 lb)

Standard Delivery

- STS-100 A/B sensor ■ Sensors delivered in aluminum case ■
- Accredited calibration certificate, 6 points from -45 to 650° C ■
- Cable – according to order number ■ User manual.

Accessories

122801	Cable 0.5 m (1.6 ft) LEMO to LEMO
65-PT100-LL-CABLE	Cable 2 m (6.6 ft) LEMO to LEMO
65-PT100-LB-CABLE	Cable 2 m (6.6 ft) LEMO to Banana
125522	Cable 2 m (6.6 ft) with LEMO/Redel for DTI050 RTC/PTC

Ordering Information

Base Model Number	Sensor Diameter	Shape and Length	Cable Length and Termination	Calibration Certificate
STS100	_____	_____	_____	_____
Pt100 reference sensor, solid, -150 to 650° C (-238 to 1207° F)	Overall diameter 4 mm (0.16 in) A	Straight sensor, 250 mm (9.8 in) in aluminum case ... 250	0.5 m (1.6 ft), with LEMO connector A	Accredited certificate. ISO17025. Standard -45 to 650° C ... H
	Overall diameter 6.35 mm (0.25 in) ... B	Straight sensor, 350 mm (13.8 in) in aluminum case ... 350	2 m (6.6 ft), with LEMO connector B	Accredited certificate. ISO17025. Standard -90 to 125° C ... HL
		Straight sensor, 500 mm (19.7 in) in aluminum case ... 500	2 m (6.6 ft), with banana plug connector ... C	No certificate (Annealed only) I Useless without calibration certificate / coefficients.

Sample Order Number

STS100A350BH ... 4 mm STS-100 reference sensor, straight 350 mm, cable length 2 m (6.6 ft) with LEMO connector, and accredited calibration certificate.

STS-102 A

Cable Type

For sanitary sensor calibration, JOFRA has also designed a special cable type reference sensor, the STS-102 A. Due to the small size and flexible connection, the design permits positioning of the sensor throughout the depth of the well in a dry-block, eg. under a sanitary flange.

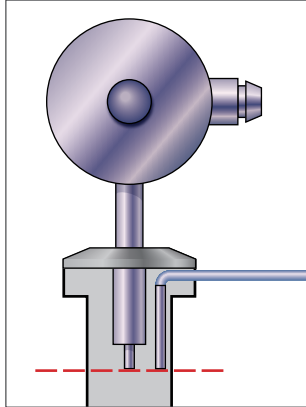

The reference sensor must be placed at the same level and in parallel with the sensor-under-test as indicated in the illustration above. The illustration shows calibration of a sanitary sensor. The sensor is in contact with the insert.

Standard Delivery

- STS-102 A sensor ■ Sensors delivered in plastic case ■
- Accredited calibration certificate, 6 points from -45 to 155° C ■
- Cable – according to order number ■ User manual ■
- Calibration Tube.

Ordering Information

Base Model Number	Sensor Diameter	Shape and Length	Cable Length and Termination	Calibration Certificate
STS102	A	030	_____	_____
Pt100 reference sensor, cable, -50 to 155° C (-58 to 311° F)	Overall diameter 4 mm (0.16 in)	Short sensor, 30 mm (1.18 in) in plastic case	1 m (3.3 ft), integrated Teflon cable, with LEMO connector ... S	Accredited certificate. ISO17025. Standard -45 to 155° C ... H
			1 m (3.3 ft), with REDEL connector for DTI050 D	No certificate (Annealed only) I
			1 m (3.3 ft), with LEMO/REDEL connector for RTC. E	Useless without calibration certificate / coefficients.

Sample Order Number

STS102A030DH ... 4 mm STS-102, short 30 mm reference sensor, cable length 1 m (3.3 ft) with REDEL connector for DTI050, and accredited calibration certificate.



The custom insert and STS-102 A reference sensor placed in a JOFRA RTC 156 dry-block calibrator. On the right, the sanitary sensor has been fitted into the insert and is ready for calibration. Note that the design makes room for the reference sensor cable.

JOFRA
calibration

Specifications

Temperature Range

All Sensors -50 to 155° C (-58 to 311° F)

Accuracy

Hysteresis @ 0° C (32° F) 0.01° C (0.018° F)
 Long Term Stability ⁽¹⁾ @ 0° C (32° F) typical 0.025° C (0.045° F)
 Repeatability @ 0° C (32° F) 0.002° C (0.0036° F)
 (1) When exposed to 155° C (311° F) for 200 hours. Stability will depend on actual use of the sensor.

Sensing Element

Type Pt100
 Nominal Resistance @ 0° C (32° F) 100 Ω
 Temperature Coefficient α₁₀₀ = 0.00385 1/°C

Minimum Immersion Depth

30 mm (1.18 in)

Self-Heating Effect

0.06° C/mW (0.108° F/mW)

Response Time

τ_{0.9} (90%) 16 seconds
 Measured in water.

Electrical Connections

Cable 4-wire plus shield
 Connection LEMO goldplated

Insulation Resistance

@ 23° C (73° F) 3 Gohm

Outer Tube

AISI 316TI

Operating Conditions

Sensor Connection Max. 70° C (158° F)
 Sensor Cable Max. 175° C (347° F)
 Storage Temperature -20 to 70° C (-4 to 158° F)
 Humidity 0 to 90% RH
 Protection Class (connectors) DIN 40050 IP-50

Shipping Dimensions

LxWxH 220x250x60 mm (8.7x9.8x2.4 in)
 Shipping Weight, including packing 550 g (1.2 lb)

Accessories

Complete application kit for calibration of sanitary sensors including, STS102A030SH, Recalibration Tube, Manual, 5-pack Undrilled Insertion Tubes with Cable Grove, and Carrying Case.

Order No. 123859



STS-103 B

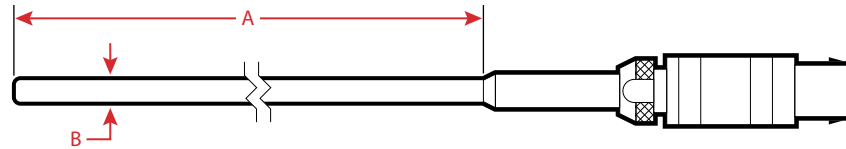

ETC-400 R Calibrator Sensor

JOFRA has designed a special 3 mm STS reference sensor for the ETC-400 R calibrator. The sensor can be used as a reference sensor when a higher accuracy is required, or for recalibration of the ETC-400 R. Due to the small immersion depth requirement of the sensor, it can be placed under the surface of the target.

Standard Delivery

- STS-103 B sensor ■ Sensor delivered in aluminum case ■
- Accredited calibration certificate, 6 points from -45 to 400° C ■
- Cable – according to order number ■ User manual.

Accessories

- 122801 Cable 0.5 m (1.6 ft) LEMO to LEMO
- 65-PT100-LL-CABLE Cable 2 m (6.6 ft) LEMO to LEMO
- 65-PT100-LB-CABLE Cable 2 m (6.6 ft) LEMO to Banana
- 125522 Cable 2 m (6.6 ft) with LEMO/Redel for DTI050

Specifications

Dimensions

Reference A 150 mm (5.91 in)
Reference B 3 mm (0.12 in)

Temperature Range

All Sensors -50 to 400° C (-58 to 752° F)

Accuracy

Hysteresis ⁽¹⁾ @ 0° C (32° F) 0.01° C (0.02° F)
Long Term Stability ⁽²⁾ @ 0° C (32° F) typical 0.014° C (0.025° F)
Repeatability ⁽¹⁾ @ 0° C (32° F) 0.005° C (0.009° F)

- (1) When used in the range -45 to 400° C (-49 to 752° F).
- (2) When exposed to 400° C (752° F) for 100 hours. Stability will depend on actual use of the sensor.

Sensing Element

Type Pt100
Nominal Resistance @ 0° C (32° F) 100 Ω
Temperature Coefficient $\alpha_{100} = 0.00385$ 1/°C

Minimum Immersion Depth

40 mm (1.6 in)

Self-Heating Effect

0.06° C/mW (0.108° F/mW)

Response Time

$\tau_{0.5}$ (50%)5 seconds
 $\tau_{0.9}$ (90%) 15 seconds

Liquid in motion $v = 0.4$ m/s.

Electrical Connections

Cable 4-wire plus shield
Connection LEMO goldplated

Insulation Resistance

@ 23° C (73° F) 100 Gohm
@ 400° C (752° F) 70 Mohm

Outer Tube

Incoel 600

Operating Conditions

Sensor, Connection, and Cable Max. 70° C (158° F)
Storage Temperature -20 to 70° C (-4 to 158° F)
Humidity 0 to 90% RH
Protection Class (connectors) DIN 40050 IP-50

Shipping Dimensions

LxW.H 750x140x140 mm (29.5x5.5x5.5 in)
Shipping Weight, including packing 2 kg (4.4 lb)

Ordering Information

Base Model Number	Sensor Diameter	Shape and Length	Cable Length and Termination	Calibration Certificate
STS103	B	150	_____	_____
Pt100 reference sensor, -50 to 400° C (-58 to 752° F)	Overall diameter 3 mm (0.12 in)	Straight sensor, 150 mm (5.9 in)	0.5 m (1.6 ft), with LEMO connector A	Accredited certificate. ISO17025. Standard -45 to 400° C ... H
			2 m (6.6 ft), with LEMO connector B	No certificate (Annealed only) I
			2 m (6.6 ft), with banana plug connector ... C	Useless without calibration certificate / coefficients.

Sample Order Number

STS103B150AH ... 3 mm STS-103, straight 150 mm reference sensor, cable length 0.5 m (1.6 ft) with LEMO termination, and accredited calibration certificate.

STS-120 A

Specifications

Dimensions

Reference A (915)	140 mm (5.51 in)
(935)	135 mm (5.31 in)
(966)	151 mm (5.94 in)
Reference B	4 mm (0.16 in)

Temperature Range

STS-120 A -915	-45 to 155° C (-49 to 311° F)
STS-120 A -935	0 to 350° C (32 to 662° F)
STS-120 A -966	0 to 660° C (32 to 1220° F)

Accuracy

Dead Band ⁽¹⁾ @ 0° C (32° F)	0.01° C (0.02° F)
Long Term Stability ⁽²⁾ @ 0° C (32° F)	typical 0.014° C (0.025° F)
Repeatability ⁽¹⁾ @ 0° C (32° F)	0.004° C (0.007° F)

(1) When used in the range shown above.

(2) When exposed to the maximum temperature shown above for 100 hours. Stability will depend on the actual use of the sensor.

Sensing Element

Type	Pt100
Nominal Resistance @ 0° C (32° F)	100 Ω
Temperature Coefficient	$\alpha_{100} = 0.00385$ 1/°C

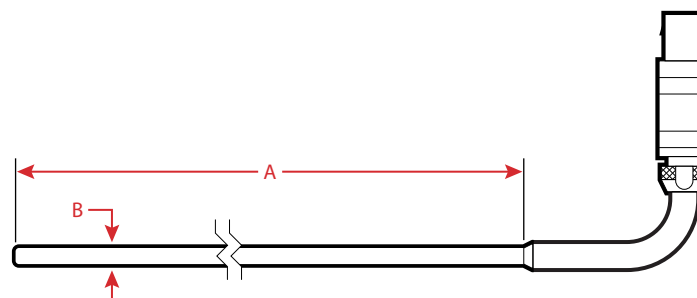

Minimum Immersion Depth

STS-120 A -915/935	60 mm (2.36 in)
STS-120 A -966	100 mm (3.93 in)

Self-Heating Effect

0.06° C/mW (0.108° F/mW)

Response Time

STS-120 A -915/935: $\tau_{0.5}$ (50%)	7 seconds
STS-120 A -915/935: $\tau_{0.9}$ (90%)	18 seconds
STS-120 A -966: $\tau_{0.5}$ (50%)	8 seconds
STS-120 A -966: $\tau_{0.9}$ (90%)	26 seconds

Electrical Connections

Cable	4-wire plus shield
Connection	Redel
STS-120 A -915/935	Cable with Redel connector and memory
STS-120 A -966	LEMO plug with memory

Outer Tube

Inconel 600

Operating Conditions

Sensor, Connection, and Cable	Max. 70° C (158° F)
Storage Temperature	-20 to 70° C (-4 to 158° F)
Humidity	5 to 90% RH
Protection Class (connectors)	DIN 40050 IP-50

Shipping Dimensions

LxWxH	335x30x270 mm (13.1x1.2x10.6 in)
Shipping Weight, including packing	1.9 kg (4.2 lb)

Standard Delivery

STS-120 A sensor ■ Sensors delivered in plastic case ■ Accredited calibration certificate, 5 to 7 points ■ Cable – according to order number ■ User manual.

Ordering Information

Base Model Number	Sensor Diameter	Shape and Length	Cable Length and Termination	Calibration Certificate
STS120	A	—	E	—
Pt100 reference sensor, solid, with intelligence	Overall diameter 4 mm (0.16 in)	90° angled sensor, 140 mm (5.5 in) in plastic case. 915 90° angled sensor, 135 mm (5.3 in) in plastic case. 935 90° angled sensor, 151 mm (5.9 in) in plastic case. 966	0.5 m (1.6 ft), with LEMO/Redel connector	Accredited certificate. ISO17025. Standard -45 to 660° C H No certificate (Annealed only)

Sample Order Number

STS120A915EH ... 4 mm STS-100 reference sensor, 90° angled, 140 mm, cable length 0.5 m (1.6 ft) with LEMO/Redel connector, and accredited calibration certificate.

STS-150 A

Specifications

Dimensions

Reference A (912)	210 mm (8.26 in)
(915)	180 mm (7.08 in)
(935)	165 mm (6.49 in)
(966)	201 mm (7.91 in)
Reference B	4 mm (0.16 in)

Temperature Range

STS-150 A - 912	-90 to 155° C (-130 to 311° F)
STS-150 A - 915	-25 to 155° C (-13 to 311° F)
STS-150 A - 935	0 to 350° C (32 to 662° F)
STS-150 A - 966	0 to 660° C (32 to 1220° F)

Accuracy

Hysteresis ⁽¹⁾ @ 0° C (32° F)	0.01° C (0.02° F)
Long Term Stability ⁽²⁾ @ 0° C (32° F)	typical 0.016° C (0.029° F)
Repeatability ⁽¹⁾ @ 0° C (32° F)	0.004° C (0.007° F)

(1) When used in the range shown above.

(2) When exposed to the maximum temperature shown above for 100 hours.
Stability will depend on the actual use of the sensor.

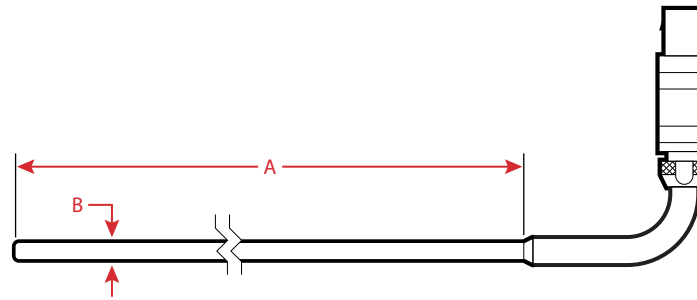

Sensing Element

Type	Pt100
Nominal Resistance @ 0° C (32° F)	100 Ω
Temperature Coefficient	$\alpha_{100} = 0.00385$ 1/°C

Minimum Immersion Depth

STS-150 A - 912/915/935	60 mm (2.36 in)
STS-150 A - 966	100 mm (3.93 in)

Self-Heating Effect

0.06° C/mW (0.108° F/mW)

Response Time

STS-150 A - 912/915/935 : $\tau_{0.5}$ (50%)	7 seconds
STS-150 A - 912/915/935 : $\tau_{0.9}$ (90%)	18 seconds
STS-150 A - 966 : $\tau_{0.5}$ (50%)	8 seconds
STS-150 A - 966 : $\tau_{0.9}$ (90%)	26 seconds

Electrical Connections

Cable	4-wire plus shield
Connection	Redel
STS-150 A - 912/915/935 .Cable w/ Redel connector and memory	
STS-150 A - 966	LEMO plug with memory

Outer Tube

Inconel 600

Operating Conditions

Sensor, Connection, and Cable	Max. 70° C (158° F)
Storage Temperature	-20 to 70° C (-4 to 158° F)
Humidity	5 to 90% RH
Protection Class (connectors)	DIN 40050 IP-50

Shipping Dimensions

LxWxH	335x30x270 mm (13.1x1.2x10.6 in)
Shipping Weight, including packing	1.9 kg (4.2 lb)

Standard Delivery

STS-150 A sensor ■ Sensors delivered in plastic case ■ Accredited calibration certificate, 5 to 7 points ■ Cable – according to order number ■ User manual.

Ordering Information

Base Model Number	Sensor Diameter	Shape and Length	Cable Length and Termination	Calibration Certificate
STS150	A	_____	E	_____
Pt100 reference sensor, solid, with intelligence	Overall diameter 4 mm (0.16 in)	90° angled sensor, 210 mm (8.2 in) in plastic case. 912	0.5 m (1.6 ft), with LEMO/Redel connector	Accredited certificate. ISO17025. Standard -25 to 660° C H
		90° angled sensor, 180 mm (7.0 in) in plastic case. 915		No certificate (Annealed only)
		90° angled sensor, 165 mm (6.5 in) in plastic case. 935		Useless without calibration certificate / coefficients. I
		90° angled sensor, 201 mm (7.9 in) in plastic case. 966		

Sample Order Number

STS150A935EH ... 4 mm STS-100 reference sensor, 90° angled, 165 mm, cable length 0.5 m (1.6 ft) with LEMO/Redel connector, and accredited calibration certificate.

STS-200 A/B

Specifications

Dimensions

Reference A (915)	160 mm (6.29 in)
(916)	182 mm (7.16 in)
(917)	192 mm (7.55 in)
(925)	182 mm (7.16 in)
(970)	225 mm (8.85 in)
Reference B	4 mm (0.16 in)
	6.35 mm (0.25 in)

Temperature Range

STS-200 A -915	-65 to 160° C (-85 to 320° F)
STS-200 A -916	-65 to 160° C (-85 to 320° F)
STS-200 A -917	-100 to 155° C (-148 to 311° F)
STS-200 A -925	0 to 250° C (32 to 482° F)
STS-200 A -970	0 to 700° C (32 to 1292° F)

Accuracy

Hysteresis ⁽¹⁾ @ 0° C (32° F)	0.01° C (0.02° F)
Long Term Stability ⁽²⁾ @ 0° C (32° F)	typical 0.016° C (0.029° F)
Repeatability ⁽¹⁾ @ 0° C (32° F)	0.002° C (0.0036° F)

(1) When used in the range shown above.

(2) When exposed to the maximum temperature shown above for 100 hours. Stability will depend on the actual use of the sensor.

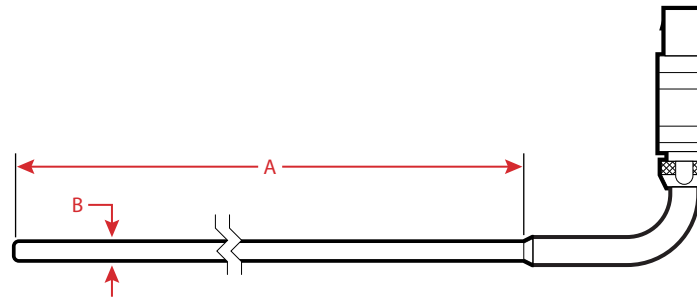

Sensing Element

Type	Pt100
Nominal Resistance @ 0° C (32° F)	100 Ω
Temperature Coefficient	$\alpha_{100} = 0.00385 \text{ 1/}^\circ\text{C}$

Minimum Immersion Depth

STS-200 A — 4 mm (0.16 in)	100 mm (3.9 in)
STS-200 B — 6.35 mm (0.25 in)	110 mm (4.3 in)

Self-Heating Effect

0.06° C/mW (0.108° F/mW)

Response Time

STS-200 A — 4 mm (0.16 in): $\tau_{0.5}$ (50%)	8 seconds
STS-200 A — 4 mm (0.16 in): $\tau_{0.9}$ (90%)	26 seconds
STS-200 B — 6.35 mm (0.25 in): $\tau_{0.5}$ (50%)	18 seconds
STS-200 B — 6.35 mm (0.25 in): $\tau_{0.9}$ (90%)	44 seconds

Electrical Connections

Cable	4-wire plus shield
Connection	Redel

Outer Tube

Inconel 600

Operating Conditions

Sensor, Connection, and Cable	Max. 70° C (158° F)
Storage Temperature	-20 to 70° C (-4 to 158° F)
Humidity	5 to 90% RH
Protection Class (connectors)	DIN 40050 IP-50

Shipping Dimensions

LxWxH	335x30x270 mm (13.1x1.2x10.6 in)
Shipping Weight, including packing	1.9 kg (4.2 lb)

Standard Delivery

STS-200 A/B sensor ■ Sensors delivered in plastic case ■ Accredited calibration certificate, 6 to 7 points ■ Cable – according to order number ■ User manual.

Accessories

127131	Cable 0.5 m (1.6 ft) w/ 6-POL LEMO/Redel for RTC
127285	Cable 2 m (6.6 ft) w/ 6-POL LEMO/Redel for RTC
127286	Cable 2 m (6.6 ft) w/ 6-POL LEMO/Banana connector
127287	Cable 2 m (6.6 ft) w/ 6-POL LEMO to 4-POL LEMO
127288	Cable 0.5 m (1.6 ft) w/ 6-POL LEMO to 4-POL LEMO
127787	Cable 2 m (6.6 ft) w/ Male Redel/Female Redel

Ordering Information

Base Model Number	Sensor Diameter	Shape and Length	Cable Length and Termination	Calibration Certificate
STS200	_____	_____	_____	_____
Pt100 reference sensor, solid, with intelligence	Overall diameter 4 mm (0.16 in)	90° angled sensor, 160 mm (6.3 in) in plastic case.	0.5 m (1.6 ft), with LEMO/LEMO connector. ...	Accredited certificate. ISO17025. Standard -25 to 660° C.
	Overall diameter 6.35 mm (0.25 in) ...	90° angled sensor, 182 mm (7.1 in) in plastic case.	2 m (6.6 ft), with LEMO/LEMO connector. ...	No certificate (Annealed only).
		90° angled sensor, 192 mm (7.5 in) in plastic case.	2 m (6.6 ft), with LEMO/Banana connector. ...	Useless without calibration certificate / coefficients.
		90° angled sensor, 182 mm (7.1 in) in plastic case.	2 m (6.6 ft), with LEMO/Redel connector. ...	
		90° angled sensor, 225 mm (8.8 in) in plastic case.	0.5 m (1.6 ft), with LEMO/Redel connector. ...	

Sample Order Number

STS200B925DH ... 6.35 mm STS-200 reference sensor, 90° angled, 182 mm, cable length 2 m (6.6 ft) with LEMO/Redel connector, and accredited calibration certificate.

Temperature Calibrators and Reference Sensors

Calibrator	Reference Sensor			Diameter	
	Catalogue No.	Name	Shape	4 mm	1/4"
RTC-156-B & 156-C	STS102A030EH	R1	30 mm	■	
	STS200A915EH	R2	Angled	■	
	STS200B915EH	R3	Angled		■
RTC-157-B & 157-C	STS102A030EH	R1	30 mm	■	
	STS200A915EH	R2	Angled	■	
	STS200B915EH	R3	Angled		■
RTC-158-B & 158-C	STS102A030EH	R1	30 mm	■	
	STS200A916EH	R6	Angled	■	
	STS200B916EH	R7	Angled		■
RTC-159-B & 159-C	STS200A917EH	R14	Angled	■	
	STS200B917EH	R15	Angled		■
RTC-187-B & 187-C	STS200A918EH	R17	Angled	■	
	STS200B918EH	R18	Angled		■
RTC-250-B & 250-C	STS200A925EH	R8	Angled	■	
	STS200B925EH	R9	Angled		■
RTC-700-B & 700-C	STS200A970EH	R4	Angled	■	
	STS200B970EH	R5	Angled		■
PTC125-C	STS150A912EH	R16	Angled	■	
PTC155-C	STS102A030EH	R1	30 mm	■	
	STS150A915EH	R11	Angled	■	
PTC350-C	STS150A935EH	R12	Angled	■	
PTC425-C	STS150A966EH	R13	Angled	■	
PTC660-C	STS150A966EH	R13	Angled	■	
CTC155-C	STS102A030EH	R1	30 mm	■	
	STS120A915EH	R21	Angled	■	
CTC350-C	STS120A935EH	R22	Angled	■	
CTC660-C	STS120A966EH	R23	Angled	■	

Singapore

Tel +65 6484 2388
jofra@ametek.com

China, Shanghai

Tel +86 21 5868 5111
jofra.sales@ametek.com.cn

China, Beijing

Tel +86 10 8526 2111
jofra.sales@ametek.com.cn

United Kingdom

Tel +44 (0) 1243 833 302
caluk.sales@ametek.com

France

Tel +33 (0) 30 68 89 40
general.lloyd-instruments@ametek.fr

Germany

Tel +49 (0) 2159 9136 510
info.mct-de@ametek.de

Denmark*

Tel +45 4816 8000
jofra@ametek.com

ametekcalibration.com

JOFRA[®]
calibration

No part of this document may be reproduced or modified in any form or by any means, electronic or mechanical, without express written permission from Crystal Engineering Corporation.

©2018 AMETEK Incorporated

AMETEK[®]
 SENSORS, TEST & CALIBRATION

USA, Florida
 Tel +1 (800) 527 9999
cal.info@ametek.com

USA, California*
 Tel +1 (800) 444 1850
crystal@ametek.com

India
 Tel +91 22 2836 4750
jofra@ametek.com